



<b>I</b>	<i>ISTRUZIONI D'USO</i> .....	<b>3</b>
<b>GB</b>	<i>INSTRUCTIONS MANUAL</i> .....	<b>10</b>
<b>D</b>	<i>GEBRAUCHSANWEISUNGEN</i> .....	<b>17</b>
<b>F</b>	<i>INSTRUCTIONS D'EMPLOI</i> .....	<b>24</b>

# **PC-100 / PC-200**

## **DS-300**

**I**

<b>ELEMENTI PRINCIPALI DEL SISTEMA ELETTRICO</b> .....	<b>3</b>
<b>CONSIGLI E VERIFICHE</b> .....	<b>3</b>
<b>PANNELLO COMANDO "PC-100"</b> .....	<b>4</b>
<b>PANNELLO COMANDO "PC-200"</b> .....	<b>5</b>
<b>QUADRO DISTRIBUZIONE "DS-300"</b> .....	<b>7</b>
<b>SCHEMA DI INSTALLAZIONE "PC-100"</b> .....	<b>31</b>
<b>SCHEMA ELETTRICO "PC-100"</b> .....	<b>32</b>
<b>SCHEMA DI INSTALLAZIONE "PC-200"</b> .....	<b>33</b>
<b>SCHEMA ELETTRICO "PC-200"</b> .....	<b>34</b>

**GB**

<b>MAIN PARTS OF THE ELECTRICAL SYSTEM</b> .....	<b>10</b>
<b>ADVICE AND CHECKS</b> .....	<b>10</b>
<b>CONTROL PANEL "PC-100"</b> .....	<b>11</b>
<b>CONTROL PANEL "PC-200"</b> .....	<b>12</b>
<b>DISTRIBUTION BOX "DS-300"</b> .....	<b>14</b>
<b>INSTALLATION "PC-100"</b> .....	<b>31</b>
<b>WIRING DIAGRAM "PC-100"</b> .....	<b>32</b>
<b>INSTALLATION "PC-200"</b> .....	<b>33</b>
<b>WIRING DIAGRAM "PC-200"</b> .....	<b>34</b>

**D**

<b>HAUPTELEMENTE DER ELEKTRISCHE ANLAGE</b> .....	<b>17</b>
<b>RATSCHLÄGE UND KONTROLLEN</b> .....	<b>17</b>
<b>KONTROLLPANEEL "PC-100"</b> .....	<b>18</b>
<b>KONTROLLPANEEL "PC-200"</b> .....	<b>19</b>
<b>VERTEILUNGSMODUL "DS-300"</b> .....	<b>21</b>
<b>EINBAUPLAN "PC-100"</b> .....	<b>31</b>
<b>ELEKTRISCHER PLAN "PC-100"</b> .....	<b>32</b>
<b>EINBAUPLAN "PC-200"</b> .....	<b>33</b>
<b>ELEKTRISCHER PLAN "PC-200"</b> .....	<b>34</b>

**F**

<b>ELEMENTS PRINCIPAUX DU SYSTEME ELECTRIQUE</b> .....	<b>24</b>
<b>CONSEILS ET CONTROLES</b> .....	<b>24</b>
<b>PANNEAU DE COMMANDE "PC-100"</b> .....	<b>25</b>
<b>PANNEAU DE COMMANDE "PC-200"</b> .....	<b>26</b>
<b>TABLEAU DE DISTRIBUTION "DS-300"</b> .....	<b>28</b>
<b>SCHEMA D'INSTALLATION "PC-100"</b> .....	<b>31</b>
<b>SCHEMA ELECTRIQUE "PC-100"</b> .....	<b>32</b>
<b>SCHEMA D'INSTALLATION "PC-200"</b> .....	<b>33</b>
<b>SCHEMA ELECTRIQUE "PC-200"</b> .....	<b>34</b>

- ◆ CONTROL PANEL - mains' control, battery test, tank test, (PC-100 and PC-200) - temperature test and clock function (only for "PC-200).
- ◆ 12V DISTRIBUTION BOX "DS-300" - main relais, battery parallel relais (12V - 70A), fridge relais, pump relais, car battery recharging device, protection fuses.
- ◆ BATTERY CHARGER - buffer-system battery charger.
- ◆ ELECTRONIC TANK PROBE - it measures the content of the water tanks, visualization in "%". (only for "PC-200")
- ◆ 4-RODS TANKPROBE - it measures the content of the drink water tank, 4-levels visualization. (only for "PC-100")
- ◆ TANK PROBE WITH SCREWS "SS/P" - signalization of full waste water tank
- ◆ LEISURE BATTERY "B2" - it gives power to all the users
- ◆ CAR BATTERY "B1"
- ◆ ENGINE ALTERNATOR - it recharges in parallel both the car and the leisure battery
- ◆ 230V CUT-OUT board - it powers and protects all the 230V users
- ◆ "50A" CAR (B1) AND LEISURE (B2) BATTERY PROTECTION FUSES

## ADVICE AND CHECKS

### IMPORTANT

- ◆ Maintenance interventions on the electric implant may be carried out by specialized personnel.
- ◆ Before carrying out maintenances disconnect the battery and the alimentation line.

### BATTERIES

- ◆ Read with care the maintenances and instructions of use of the batteries.
- ◆ The acid kept in the batteries is poisoning and corrosive. Avoid any contact with skin and eyes.
- ◆ If the battery is completely discharged it needs recharging for almost 10 hours. If discharged for more than 8 weeks it may be damaged.
- ◆ Check periodically the level of the liquid of the battery (with acid); the GEL battery does not need any maintenance but a continuous recharging.
- ◆ Check the correct tightening of the connection binding screw and brush off the oxyde.
- ◆ If the leisure battery is removed, isolate the positive pole (in order to avoid short-circuits during an accidental car engine starting).
- ◆ In case of a longer stop the services battery has to be connected or recharged regularly.

### BATTERY CHARGER

- ◆ The battery charger must be installed in a dry and ventilated place.
- ◆ The installation of this device must be carried out by specialized technicians.
- ◆ In case of battery charger's misuse, the guarantee falls off and the manufacturer declines all responsibility for damages to people and things.
- ◆ Do not carry out any maintenance when the battery charger is connected to the 230V power supply net.
- ◆ Do not cover air intakes and assure an appropriate ventilation.
- ◆ Before disconnecting the battery charger from 230V power supply, turn the security switch off.

### TANK PROBES

- ◆ Never let water in the tanks for long time, in order to avoid foulings, especially in the waste water tank.

### 230V CUT-OUT BOX

- ◆ Before taking away the cover, check if the 230V socket is disconnected.
- ◆ In order to avoid damages to the box, check the correct tightening of the connections.
- ◆ In order to cut power to the whole 230V system, please take care that the 230V main switch must be on the "0" (OFF) position.
- ◆ Connect and disconnect the external 230V net only when the main switch is off.
- ◆ In case of automatic switch break, find the damage before giving power again to the electrical system.

### FUSES

- ◆ Replace the fuses after finding out the real cause of the damage only.
- ◆ In case the fuses are replaced respect the value of the amperage established.

## CONTROL PANEL "PC-100"

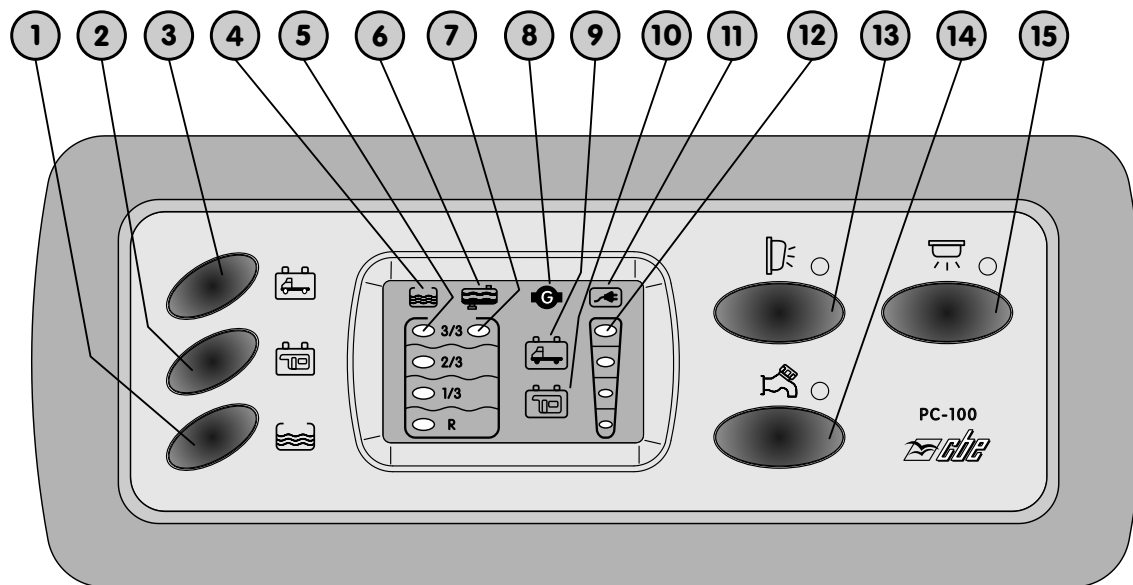

### CAPTIONS

- 1) Button to check the drink water tank.
- 2) Button to check the leisure battery (B2).
- 3) Button to check the car battery (B1).
- 4) Awning light switch, it switches automatically off when you start up the engine.
- 5) Leds to signal the drink water tank levels.
- 6) It shows the waste water tank test, the blinking indicates the full tank alarm.
- 7) Blinking led to signal the full waste water tank; the alarm is indicated also from the blinking of the led ref. 6.
- 8) It shows the car and leisure batteries recharging through engine alternator.
- 9) It shows the car battery (B1) test, the blinking indicates the discharged battery alarm.
- 10) It shows the leisure battery (B2) test, the blinking indicates the discharged battery alarm.
- 11) Led to signal 230V net on.
- 12) Led-Voltmeter to check the voltage of the car and leisure batteries.
- 13) Awning light switch; this ext. light switches automatically off when you start up the engine, depends on the main switch.
- 14) Waterpump switch; it controls the pump relays and depends on the main switch.
- 15) Mains' general switch, the blinking of the led indicates that the battery is discharged and the next intervention of the minimal voltage control.

## CONTROL PANEL "PC-200"

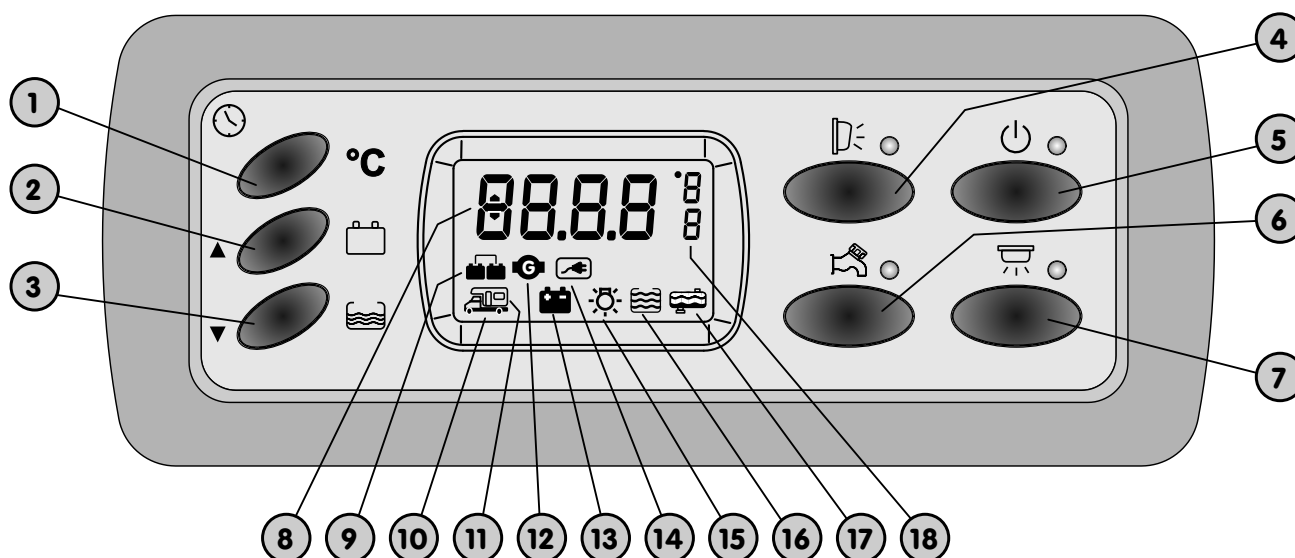

### CAPTIONS

- 1) Test button to check both internal and external temperature and to set the clock.
- 2) Test button to check the voltage of the car battery(B1) and leisure (B2) battery and to set the clock.
- 3) Test button to check the level in % of the drink and waste water tank and to set the clock.
- 4) Awning light switch, it switches automatically off when you start up the engine.
- 5) Main switch (see minimal voltage control).
- 6) Water pump switch.
- 7) Lights main switch.
- 8) Digital displaying of the clock and the required test.
- 9) It shows the starting up of the battery parallel when the engine is started.
- 10) It shows the car (B1) battery test, the blinking means run-down battery alarm.
- 11) It shows the leisure (B2) battery test, the blinking means run-down battery alarm.
- 12) It shows the battery recharging through engine alternator.
- 13) It shows the test or alarm batteries together with the symbols 10 or 11.
- 14) It shows the connection to the 230V net.
- 15) It shows that the minimal voltage device has switched on.
- 16) It shows the drink water and auxiliary tank test, if blinking shows the alarm of empty drink water or auxiliary tank.
- 17) The blinking means full tank alarm.
- 18) It shows the unit of measure: U=Volt, °C and temperature reference I=int. temperature, E=ext. temperature.

**NOTE:** The watch is supplied from the leisure battery (B2).

Should B2 be disconnected, the watch is able to keep working, without visualization, for about 2 weeks.

### TANKS SETTING

NB: do not modify the dip-switches' position of the picture.

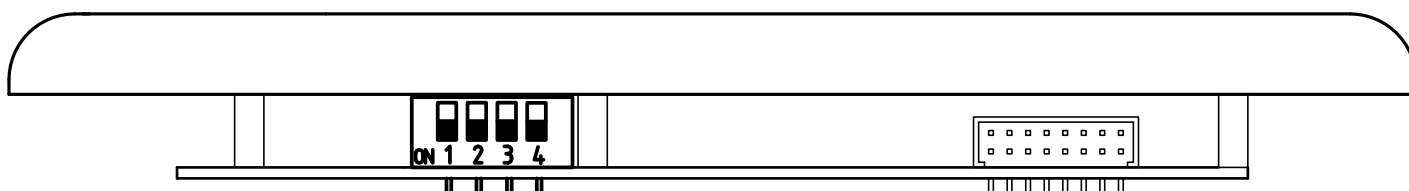

## FUNCTIONS

### MINIMAL VOLTAGE CONTROL

An electronic device switches all the 12V mains off, when the leisure battery reaches the minimal voltage level of 10V. It is possible to switch on again all the mains for 1 minute by switching off and then on again the main switch.

They are also automatically switched on again when the voltage is  $> 12V$ .

The fridge, the electrical step and the mains powered directly from B2 are excluded from this device.

### DRINK WATER TANK REFILLING (only for "PC-200")

This function is used during the drink water tank refilling and it shows the level reached by the water.

You switch on this function by visualizing the drink water tank and by keeping pushed the tank switch for more than 3 seconds.

When this function is on, you see getting lightened, in sequence, the horizontal segments of the number ref. 18 and the panel emits sounds in order to warn that the tank is getting filled:

1 short sound at 75%, 2 short sounds at 85% and 1 long sound at 95%.

### ELECTRONIC TANKPROBE (only for "PC-200")

The electronic tankprobe mod. "SPE" is a capacitive tankprobe. It is powered with 5V and a back-signal from 0 to 2,5V.

Each 8 seconds the microprocessor gives power to the tankprobe; it is also powered each time you push the tank-test button. This was studied in order to avoid useless consumption.

The tank probe has been already programmed by CBE, but it is still possible to check the correct working of the tankprobe and its setting by following these instructions:

- activate the function "DRINK WATER TANK REFILLING"
- in this way the tankprobe gets a continue power supply of 5V, so that you can control with a voltmeter the back-signal of 2,5V and you can also adjust, by using the tankprobe's trimmer, possible small variations. (i.e. tank 100 L : value "0 V" = 0 %, value "2,5 V" = 100 %).
- switch the main switch off and then on again.

### TEMPERATURE (only for "PC-200")

- Internal and external temperatures are measured through sensors which are placed inside and outside of the vehicle.

- The measuring precision is  $\pm 1^{\circ}C$ .

### CLOCK (only for "PC-200")

When one switches on the panel, the time gets displayed; after every test-function the time gets displayed again.

In order to set the clock, keep pushing for 2 secs the test button ref. 1 while the time gets displayed. The hours' digits start blinking and by pushing the test buttons ref. 2 e ref. 3 one can modify their value.

By pushing the test button ref. 1 again, one can start setting the minutes' digits.

By pushing the test button ref. 1 for the third time, one confirms the clock setting.

### SETUP (only for "PC-200")

To enter the programmation menu turn on the control panel with the switch ref. 5 while keeping pushed the buttons ref. 2 and 3.

The programmation is sequential: to shift to the next parameter push the button ref. 1.

1. Voltmeter B1. With the buttons ref. 2 and 3 one can modify the displayed value in 0,2V steps

2. Voltmeter B2. With the buttons ref. 2 and 3 one can modify the displayed value in 0,1V steps

3. Amperemeter B2 (N.C).

4. Internal temperature. With the buttons ref. 2 and 3 one can modify the displayed value in 0,5°C steps

5. External temperature. With the buttons ref. 2 and 3 one can modify the displayed value in 0,5°C steps

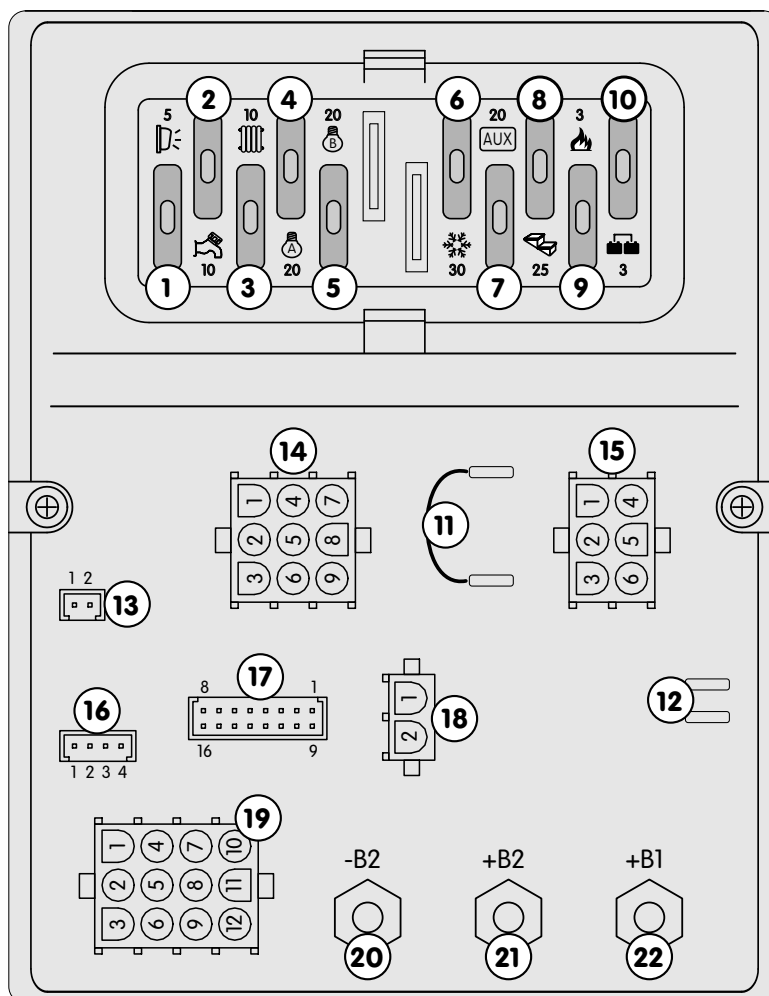

Pushing again the button ref. 1 you exit the programmation menu.

## "DS-300" DISTRIBUTION BOX

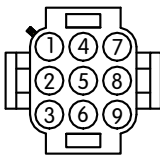
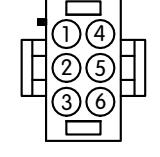
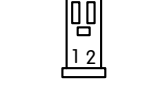
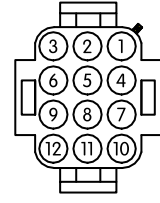
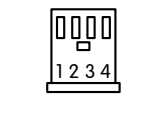
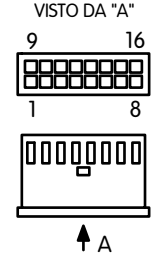

- 1) 5A fuse to give power to the awning light, it depends on the main switch and it switches automatically off when the engine is started.
- 2) 10A fuse to give power to the water pump, it depends on the main switch.
- 3) 10A fuse to give power to the heating/boiler, it depends on the lights main switch.
- 4) 20A fuse to give power to the lights group "A", it depends on the main switch.
- 5) 20A fuse to give power to the lights group "B", it depends on the main switch.
- 6) 30A fuse to give power to 12V AES or 3-way function fridge. The 3-way function fridge switches automatically off when the engine is off.
- 7) 20A fuse for the auxiliary power supply (solar regulator), which is directly connected to the leisure (B2) battery.
- 8) 25A fuse for the electrical step power supply, connected directly to the leisure (B2) battery.
- 9) 3A fuse for the gas power supply (fridge, kitchen, boiler valve, etc.), Connected directly to the leisure (B2) battery.
- 10) 3A fuse for OUT D+ simulated exit protection.
- 11) AES fridge connection; It is a bridge, which excludes the 3 way function fridge and is used to connect the AES fridge directly to the B2.
- 12) Simulated output D+ alternator to control the electrical step, AES refrigerator, electrical draining valve, coming-back of the electrical antenna.

# CONNECTIONS

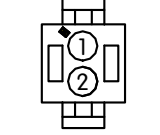
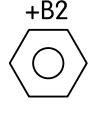
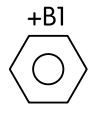
<b>14 WHITE</b> 	<b>MAINS</b> 1) + output heating, it depends on the main switch ON/OFF. 2) + output water pump - toilet, it depends on the pump switch. 3) + output awning light, it depends on the awning switch. 4-5-6) + output lights group "A", it depends on the lights switch. 7-8-9) + output lights group "B", it depends on the lights switch.	<b>FUSE (rif.)</b> 3 2 1 4 5
<b>15 WHITE</b> 	<b>MAINS</b> 1) + output aux (solar regulator), direct B2. 2-3) + output "3 way function / AES refrigerator" 4) + output electric step (direct B2). 5-6) + output gas mains' supply (fridge, kitchen, boiler valve).	<b>FUSE (rif.)</b> 7 6 8 9
<b>13 BLACK</b> 	<b>WASTE WATER TANK</b> To connect to the waste water tank probe.	<b>19 WHITE</b>  <b>MASSES</b> To connect to the mains' masses.
<b>16 BLACK</b> 	<b>DRINK WATER TANK</b> To connect to the drink water tank probe.	
<b>17 BLACK</b> VISTO DA "A" 	<b>CONTROL PANEL</b> To connect to the 16 poles connector of the control panel.	<b>20</b>  <b>MASSES</b> To connect to the negative pole of the services battery or to the chassis of the vehicle.
<b>18 WHITE</b> 	<b>SIGNALS</b> 1) + input signal contact key engine starting. 2) + input signal "S" net coming from the CBE battery charger	<b>21</b>  <b>SERVICES BATTERY</b> To connect to the positive pole of the services battery.
		<b>22</b>  <b>CAR BATTERY</b> To connect to the positive pole of the car battery.



## **FUNCTIONS**

### **CAR BATTERY (B1) RECHARGING**

When the battery charger is charging, an electronic device allows a recharging (max 2A) of the car battery (B1), the system gives priority to the leisure battery (B2).

### **LEISURE BATTERY (B2) RECHARGING**

a) by alternator: through the separating relais, when the engine is started. The +KEY engine starting controls electronically a small relais which controls the other relais: parallel, fridge, awning light, etc.

b) by 230V net: buffer system through battery charger (see "*battery charger*").

c) by solar panel: through a solar regulator.

### **ELECTRONIC BATTERY SEPARATOR**

An electronic device, which is controlled by the + Key engine starting, switches on the battery parallel when the alternator voltage is under 13,3V and switches it off when the engine starting key is off or the voltage is under 12V.

This device controls also the awning light's relais, which works only when the engine is off.

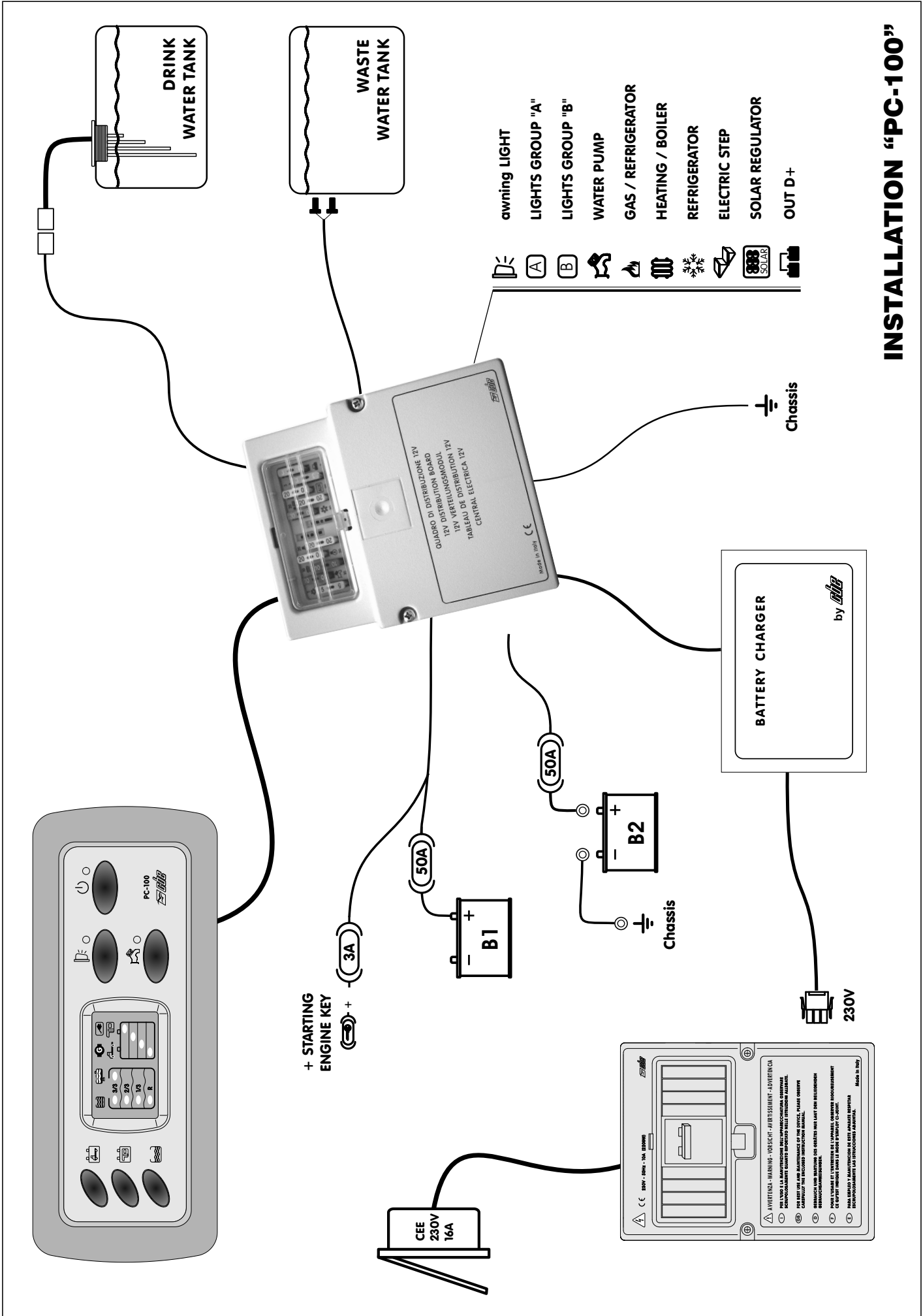

# INSTALLATION "PC-100"

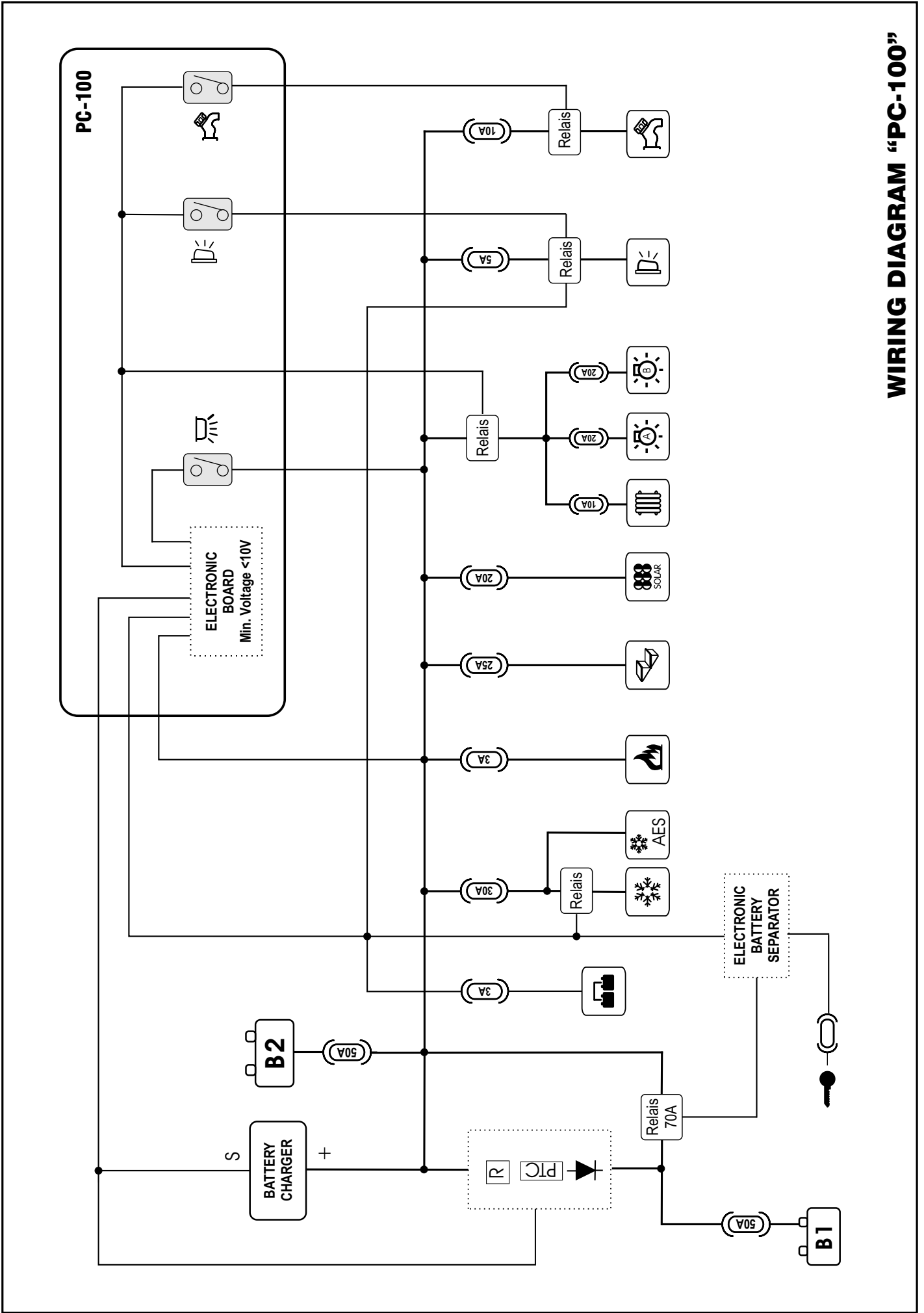

**WIRING DIAGRAM "PC-100"**

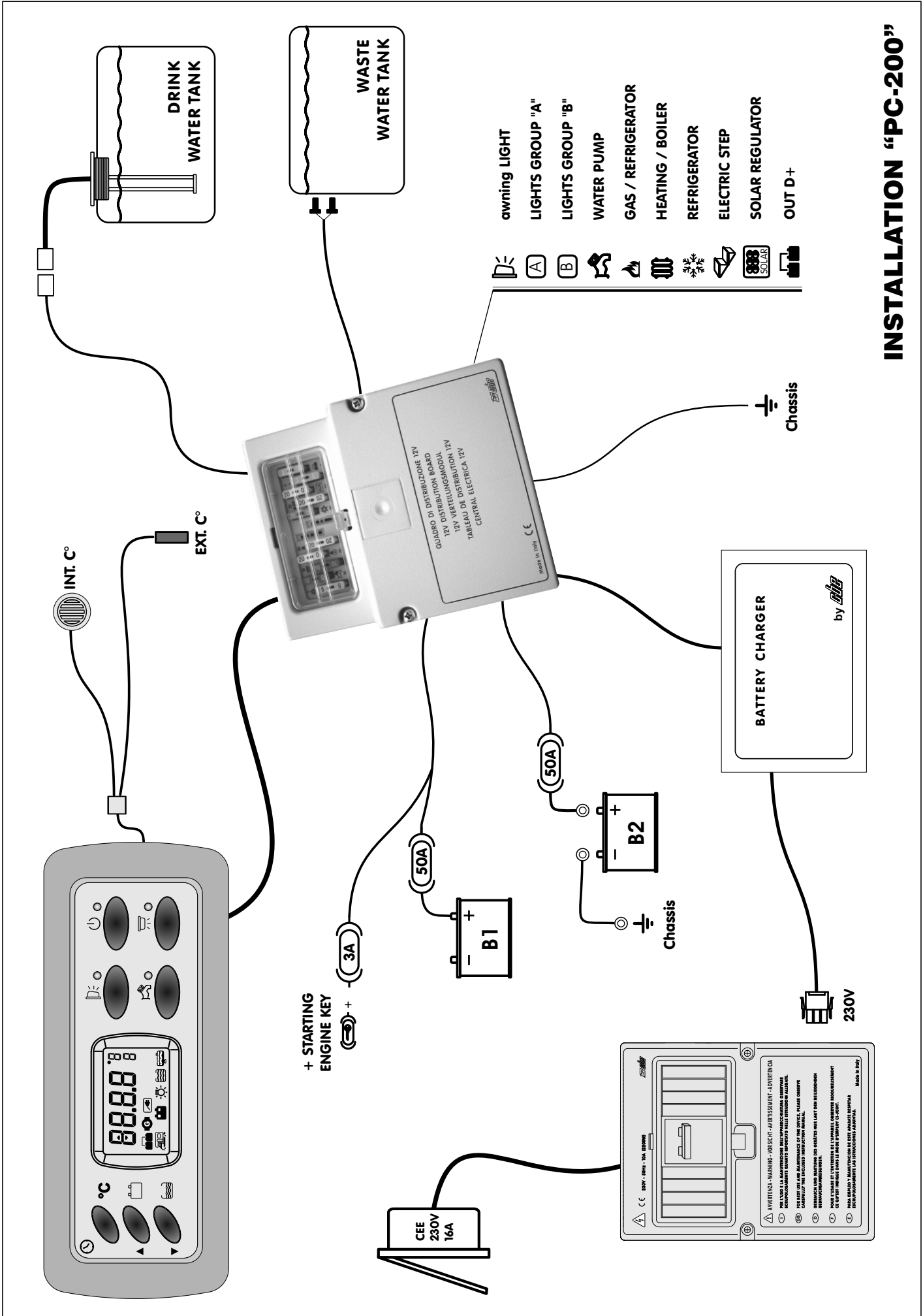

# INSTALLATION "PC-200"

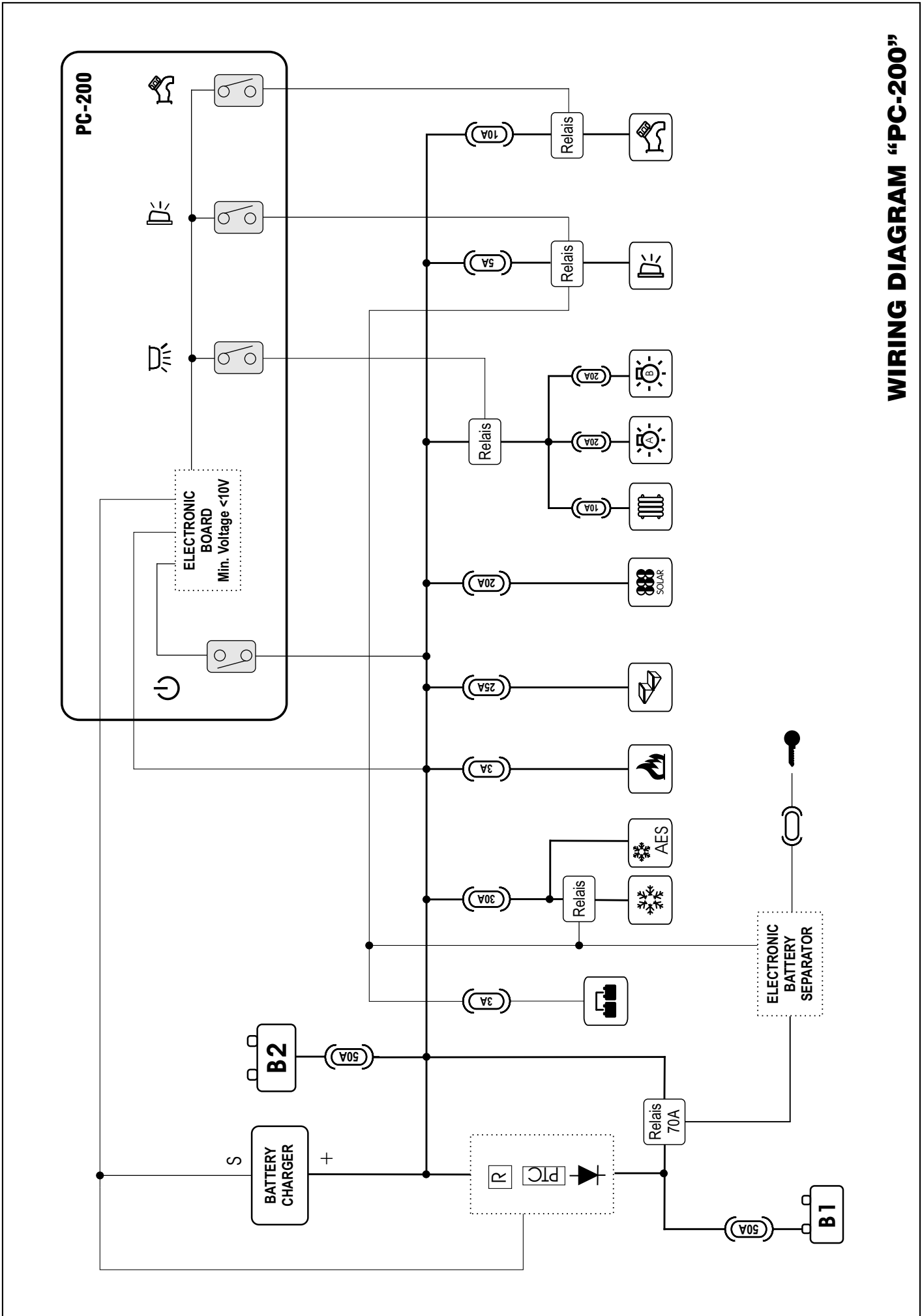

**WIRING DIAGRAM "PC-200"**